



STOCK ALUMINUM EXTRUSION CATALOG

TABLE OF CONTENTS

Abbreviation Key	2
Angles.....	3
Bars & Flats.....	4
Channels.....	5, 6
Vinyl Extrusions	7
Mirror Moldings	8
Corner Moldings.....	9
Divider Bars.....	9
Caps/J-Bar.....	10
FRP Trim (for 3/32" panels).....	11
Product Index.....	12

NOTE: Freight Charges

Lengths longer than 8' will be shipped via common carrier or, if available, may be shipped on our own fleet of trucks. Pickup may also be available. Please call for details. Freight charges will be applied at time of invoice. All material is housed and shipped from our Livermore, CA branch.

NOTE: Custom Lengths and Adhesive Backing

Please contact us if you are interested in custom lengths, adhesive backing for use in, for example, retrofit window trim. All of these are available for a fee.

ABBREVIATION KEY

BG	Bright Gold Anodized
BLX	Chrome Anodized
DA	Dark Anodized
DBRZ	Dark Bronze
MB	Matte Black
NI	Brushed Nickel
ORB	Oil Rubbed Bronze
RO	Roman Bronze
SA	Satin Anodized
TAN	Desert Tan
W	White
WP	White Paint

LOCATIONS

BOSTON	369 DOUGLAS ROAD • WHITINSVILLE, MA 01588 • 800-767-5954
LOUISVILLE	4795 SHEPHERDSVILLE ROAD • LOUISVILLE, KY 40218 • 800-826-2577
RENO	385 CABELA DRIVE • SUITE 103 • VERDI, NV 89439 • 775-440-6585

ANGLES • 1/16" WALL THICKNESS

PART #	FINISH	LENGTH	BOX QTY	FULL BOX PRICE	FULL BOX OR MORE	LESS THAN FULL BOX
HOS88	BLX	12'	48	\$684.48	\$14.26	\$16.78
A803	DBRZ	12'	50	\$651.50	\$13.03	\$15.33
A803	SA	12'	50	\$455.00	\$9.10	\$10.71
A903	SA	12'	50	\$607.00	\$12.14	\$14.28
A1425	DBRZ	12'	25	\$446.75	\$17.87	\$21.02
A1425	SA	12'	25	\$515.50	\$20.62	\$24.25

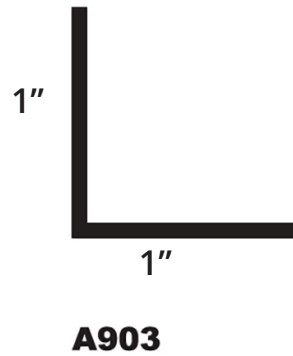
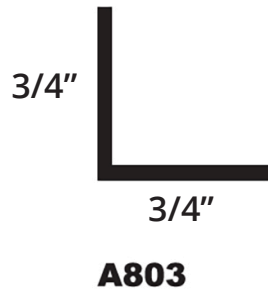
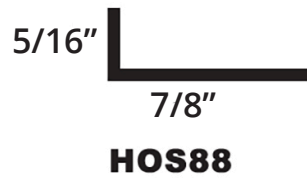

BAR & FLATS • 1/16" WALL THICKNESS

PART #	FINISH	LENGTH	BOX QTY	FULL BOX PRICE	FULL BOX OR MORE	LESS THAN FULL BOX
A12	DBRZ	12'	100	\$873.00	\$8.73	\$10.27
A12	MB	12'	100	\$1,553.00	\$15.53	\$18.28
A12	SA	12'	100	\$756.00	\$7.56	\$8.89
A12	WP	12'	100	\$1,553.00	\$15.53	\$18.28
A13	DBRZ	12'	80	\$792.80	\$9.91	\$11.66
A13	MB	12'	80	\$1,444.00	\$18.05	\$21.23
A13	SA	12'	80	\$705.60	\$8.82	\$10.38
A13	WP	12'	80	\$1,444.00	\$18.05	\$21.23
A14	DBRZ	12'	70	\$794.50	\$11.35	\$13.35
A14	MB	12'	70	\$1,443.40	\$20.62	\$24.25
A14	SA	12'	70	\$705.60	\$10.08	\$11.86
A14	WP	12'	70	\$1,443.40	\$20.62	\$24.25
A15	DBRZ	12'	60	\$762.60	\$12.71	\$14.96
A15	SA	12'	60	\$681.00	\$11.35	\$13.35
A15	WP	12'	60	\$1,390.80	\$23.18	\$27.28
HOS92	DBRZ	12'	50	\$682.00	\$13.64	\$16.04
HOS92	SA	12'	50	\$590.00	\$11.80	\$13.88

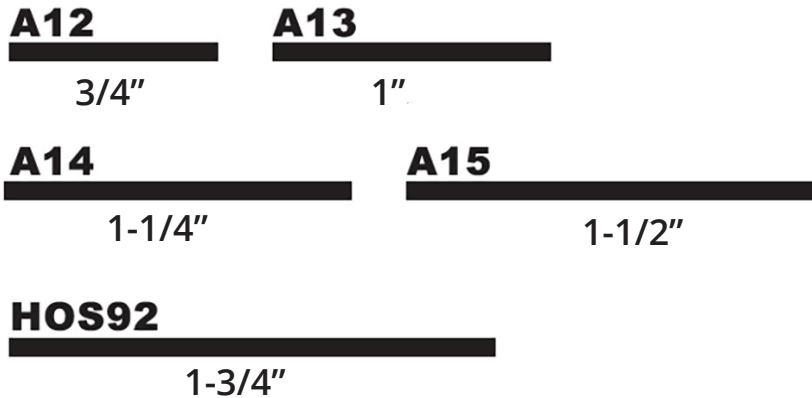

NOTE:

Most bars and flats can be purchased with "Peel & Stick" self adhesive.

Add 3.27 per pc.

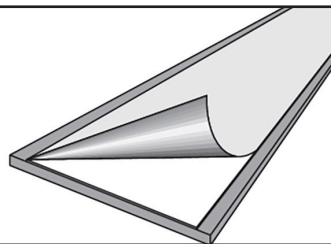

CHANNELS • 1/16" WALL THICKNESS

PART #	FINISH	LENGTH	BOX QTY	FULL BOX PRICE	FULL BOX OR MORE	LESS THAN FULL BOX
A239	SA	12'	50	\$387.00	\$7.74	\$9.11
ZD2012	BLX	12'	50	\$593.00	\$11.86	\$13.95
ZD2012	NI	12'	50	\$699.50	\$13.99	\$16.46
ZSS4103	BLX	12'	30	CALL FOR PRICING		
ZSS4103	NI	12'	30			
ZSS4103	ORB	12'	30			
ZSS4103	RO	12'	30			
ZSS4104	BG	12'	30			
ZSS4104	BLX	12'	30			
ZSS4104	DBRZ	12'	30			
ZSS4104	MB	12'	30			
ZSS4104	NI	12'	30			
ZSS4104	RO	12'	30			
ZSS4104	SA	12'	30			
A244	DBRZ	12'	50	\$670.00	\$13.40	\$15.77
ZSS5103	BLX	12'	30	CALL FOR PRICING		
ZSS5103	NI	12'	30			
ZSS5103	ORB	12'	30			
ZSS5103	RO	12'	30			
ZSS5104	BG	12'	30			
ZSS5104	BLX	12'	30			
ZSS5104	DBRZ	12'	30			
ZSS5104	MB	12'	30			
ZSS5104	NI	12'	30			
ZSS5104	ORB	12'	30			
ZSS5104	RO	12'	30			
ZSS5104	SA	12'	30			

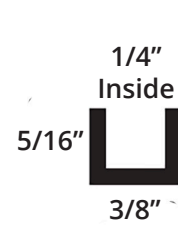

A239

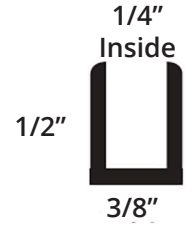

ZD 2012

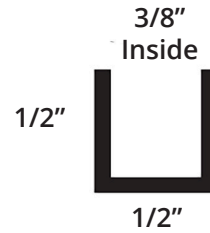

A7133

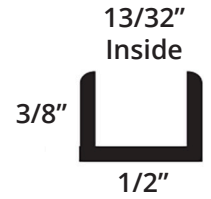

ZSS4103

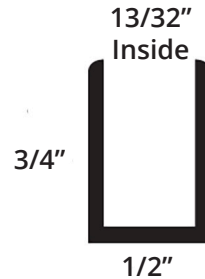

ZSS4104

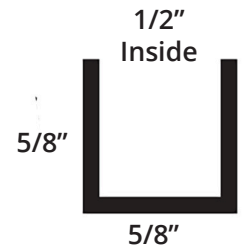

A244

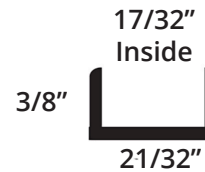

ZSS5103

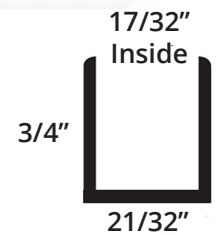

ZSS5104

CHANNELS • 3/32" WALL THICKNESS

ZSS4504	BLX	12'	12	CALL FOR PRICING
ZSS4504	MB	12'	12	
ZSS4504	NI	12'	12	
ZSS4504	RO	12'	12	

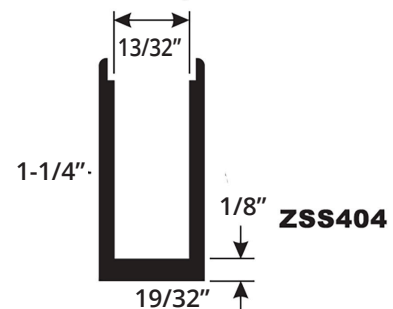

ZSS404

CHANNELS • 1/8" WALL THICKNESS

PART #	FINISH	LENGTH	BOX QTY	FULL	FULL	LESS
				BOX PRICE	BOX OR MORE	THAN FULL BOX
A1091	DBRZ	12'	12	\$315.48	\$26.29	\$30.93
A1091	SA	12'	12	\$295.44	\$24.62	\$28.96
A1101	DBRZ	12'	12	\$347.16	\$28.93	\$34.03
A1101	NI	20'	12	\$914.04	\$76.17	\$89.61
A1101	SA	12'	12	\$330.84	\$27.57	\$32.43
A1306	DBRZ	12'	12	\$563.52	\$46.96	\$55.24
A1306	SA	12'	12	\$501.72	\$41.81	\$49.19

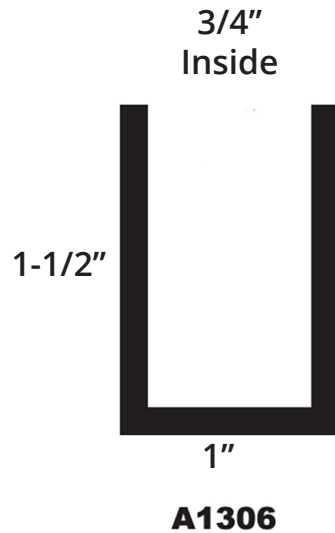
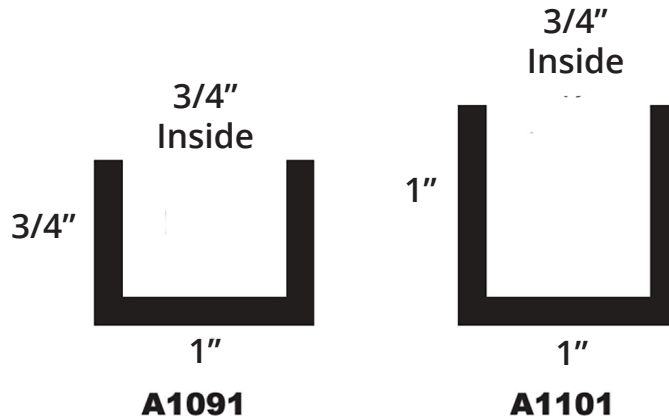

VINYL RETROFIT TRIM

PART #	FINISH	LENGTH	BOX QTY	FULL BOX PRICE	FULL BOX OR MORE	LESS THAN FULL BOX
V13	W	12'	50	\$183.00	\$3.66	\$4.30
V15	DBRZ	12'	50	\$268.00	\$5.36	\$6.30
V15	W	12'	50	\$268.00	\$5.36	\$6.30
V19	TAN	12'	50	\$280.50	\$5.61	\$6.60
V19	W	12'	50	\$280.50	\$5.61	\$6.60
V20	W	12'	50	\$318.50	\$6.37	\$7.49
V21	W	12'	50	\$361.00	\$7.22	\$8.50
V2700	W	14'	50	\$677.00	\$13.54	\$15.93

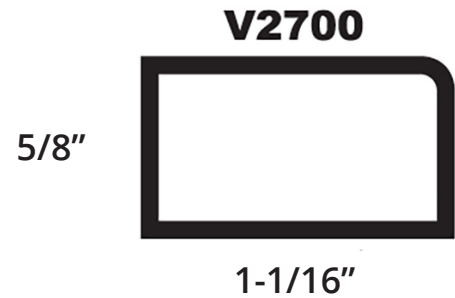

NOTE:

All these bars and flats can be purchased with "Peel & Stick" self adhesive.

Add 2.63 per pc.

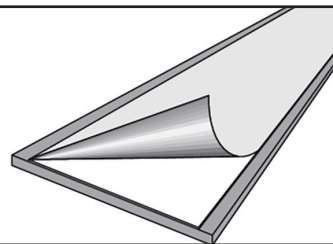

MIRROR MOLDINGS

PART #	FINISH	LENGTH	BOX QTY	FULL BOX PRICE	FULL BOX OR MORE	LESS THAN FULL BOX
A717-C	BLX	12'	72	\$717.12	\$9.96	\$11.72
A717-C	MB	12'	72	\$751.68	\$10.44	\$12.29
A717-C	NI	12'	72	\$846.72	\$11.76	\$13.83
A717-C	ORB	12'	72	\$560.96	\$9.18	\$10.80
A717-C	SA	12'	72	\$584.64	\$8.12	\$9.55
A718-C	BLX	12'	50	\$514.50	\$10.29	\$12.11
A718-C	MB	12'	50	\$544.00	\$10.88	\$12.80
A718-C	NI	12'	50	\$607.50	\$12.15	\$14.29
A718-C	ORB	12'	50	\$478.00	\$9.56	\$11.25
A718-C	SA	12'	50	\$422.50	\$8.45	\$9.94
A1817-C	BLX	12'	48	\$572.64	\$11.93	\$14.04
A1814	BLX	12'	48	\$578.88	\$12.06	\$14.19
A1815-C	BLX	12'	48	\$467.52	\$9.74	\$11.46
A1815-C	NI	12'	48	\$570.72	\$11.89	\$13.98
HOS88	BLX	12'	48	\$684.48	\$14.26	\$16.78

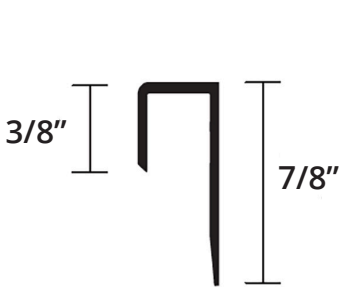

A717C

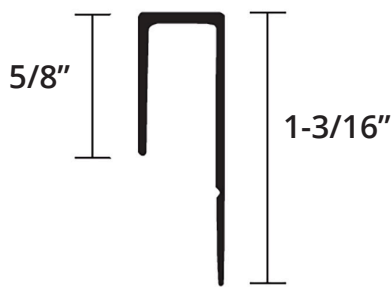

A718C

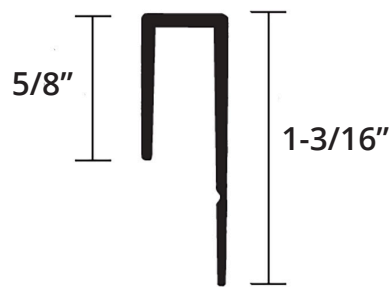

A1817C

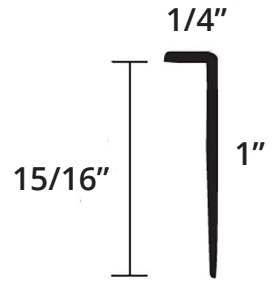

A1814

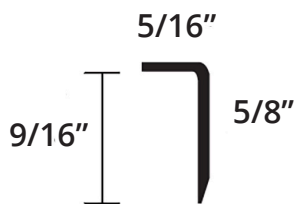

A1815-C



HOS88

CORNER MOLDINGS

PART #	FINISH	LENGTH	BOX QTY	FULL BOX PRICE	FULL BOX OR MORE	LESS THAN FULL BOX
A1882	SA	10'	100	\$1,051.00	\$9.94	\$10.51
A1883	SA	10'	100	\$813.00	\$8.13	\$9.57

**DRAWINGS BELOW
ARE NOT TO SCALE**

Panel thickness accommodated is show in parenthesis:
i.e. (1/4")

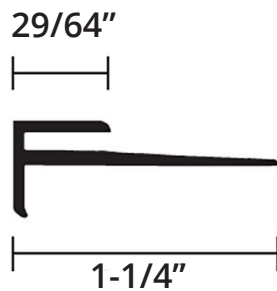

A1882 (3/32")



A1883 (3/32")

DIVIDER BARS

PART #	FINISH	LENGTH	BOX QTY	FULL BOX PRICE	FULL BOX OR MORE	LESS THAN FULL BOX
A1881	SA	10'	100	\$825.00	\$8.25	\$9.70
HOS18	SA	12'	100	\$1,030.00	\$10.30	\$12.12

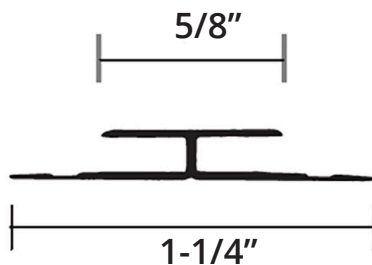

A1881 (3/32")

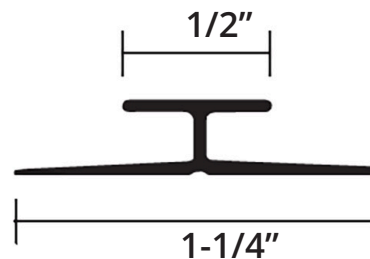

HOS18 (5/32")

CAPS / J-BAR

Panel thickness accommodated
is show in parenthesis:
i.e. (1/4")

PART #	FINISH	LENGTH	BOX QTY	FULL BOX PRICE	FULL BOX OR MORE	LESS THAN FULL BOX
A1884	SA	10'	150	\$1,099.50	\$7.33	\$8.62
A1614	SA	12'	150	\$1,441.50	\$9.61	\$11.31
A717-C	BLX	12'	72	\$717.12	\$9.96	\$11.72
A717-C	MB	12'	72	\$751.68	\$10.44	\$12.29
A717-C	NI	12'	72	\$995.76	\$11.76	\$13.83
A717-C	ORB	12'	72	\$660.96	\$9.18	\$10.80
A717-C	SA	12'	72	\$584.64	\$8.12	\$9.55
A718-C	BLX	12'	50	\$514.50	\$10.29	\$12.11
A718-C	MB	12'	50	\$544.00	\$10.88	\$12.80
A718-C	NI	12'	50	\$607.50	\$12.15	\$14.29
A718-C	ORB	12'	50	\$478.00	\$9.56	\$11.25
A718-C	SA	12'	50	\$422.50	\$8.45	\$9.94



A1884 (3/32")



A1614 (5/32")

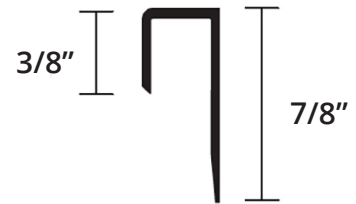

A717C (1/4")

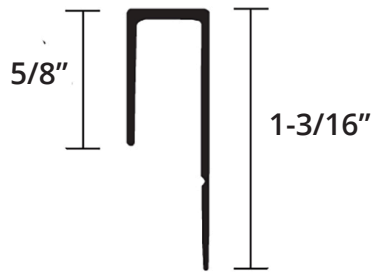

A718C (1/4")

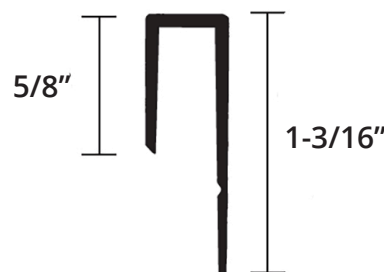

A1817C (1/4")

FRP TRIM • FOR 3/32" PANELS

Panel thickness accommodated
is show in parenthesis:
i.e. (1/4")

PART #	FINISH	LENGTH	BOX QTY	FULL BOX PRICE	FULL BOX OR MORE	LESS THAN FULL BOX
A1884	SA	10'	150	\$1,099.50	\$7.33	\$8.62
A1881	SA	10'	100	\$825.50	\$8.25	\$9.70
A1882	SA	10'	100	\$894.00	\$8.94	\$10.51
A1883	SA	10'	100	\$813.00	\$8.13	\$9.57

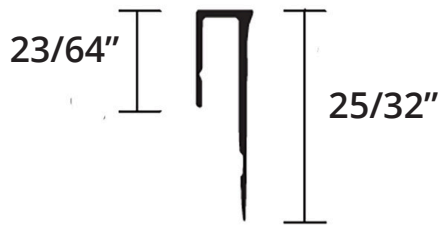

A1884 (3/32")

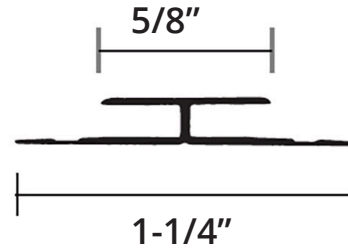

A1881 (3/32")

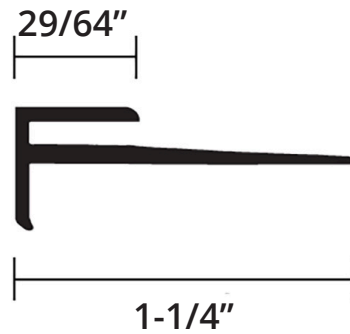

A1882 (3/32")

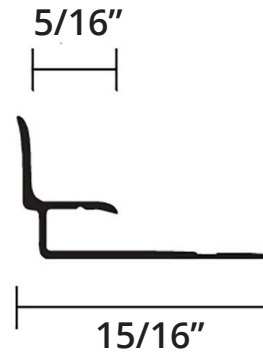

A1883 (3/32")

PRODUCT INDEX

A12	4	V13	7
A13	4	V15	7
A14	4	V19	7
A15	4	V20	7
A239	5	V21	7
A244	5	V2700	7
A717-C	8,10		
A718-C	8, 10	ZD2012	5
A803	3		
A903	3	ZSS4103	5
A1091	6	ZSS4104	5
A1101	6	ZSS4504	5
A1306	6	ZSS5103	5
A1425	3	ZSS5104	5
A1614	10		
A1814	8		
A1815-C	8		
A1817-C	8, 10		
A1881	9, 11		
A1882	9, 11		
A1883	9, 11		
A1884	10, 11		
HOS18	9		
HOS88	8		
HOS92	4		